

1 OVERVIEW

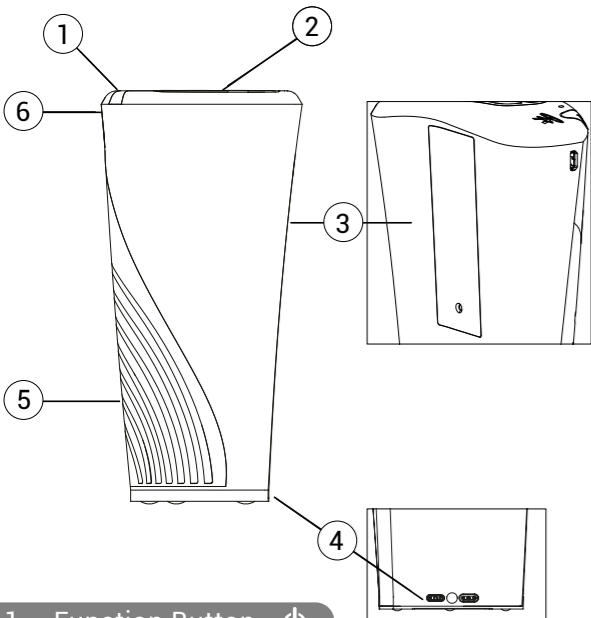

1. Function Button

Long press: turn On & Off / Short press to cycle modes

2. Out Air-vent

Clean air exits here

3. Battery Cover

Rechargeable battery

4. Pairing Link

Communication connectors

5. In Air-vent

Contaminated air enters here

6. Charging Port

Micro-USB socket

2 KEY FEATURES



ACTIVE SANITIZATION
Plascide's Micro-lightning
Anti-germ & VOCs technology



FILTER-LESS PROCESS
No germ-filled filters
No replacement cost



RAPID EFFECTIVENESS
Sanitize within seconds



CORDLESS PROTECTION
Hours of battery operation
Wherever you go

3 PACKAGE CONTENT

1. Air Halo Sanitizer
2. Li-ion battery (Installed)
3. Micro-USB to USB cable
4. Manual
5. Warranty Card

4 QUICK START GUIDE

Preparation before use:

1. On the Battery Cover remove the battery protector with the pull-out tab
2. Charge the Air Halo until battery is full
Please see:

6.4 Charging

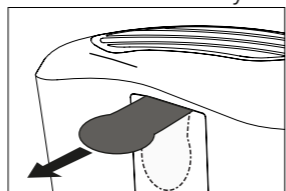

5 SAFETY PRECAUTIONS

1. Handle with care. Air Halo can be damaged if dropped, burned, punctured or crushed.
2. Do not operate if damaged and/or when the case is broken to avoid potential injury.
3. Charge with a Micro-USB cable and a compatible USB power adapter at 2.1A or higher.
4. Do not charge or operate with damaged Micro-USB cables or damaged USB power adapters.
5. Keep dry during operation and storage. Do not operate if wet and/or immersed in any liquid to avoid potential injuries and/or damages to properties.
6. Do not allow infants and/or young children to operate unsupervised.
7. Do not insert any objects into the in or out air-vents.
8. Do not operate without the Out air-vent cover.
9. Do not block the In or Out air-vents during operation.
10. Do not incinerate the Li-ion battery. Recycle or dispose separately from household waste.

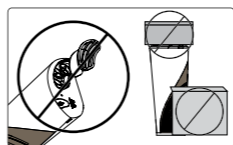
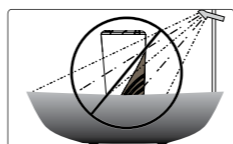
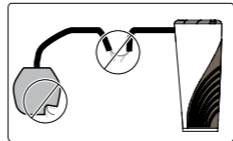
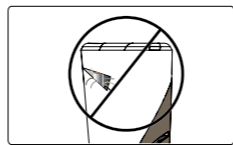
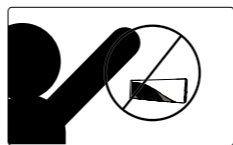

6 OPERATION GUIDE

6.1 Function Button

1. Long press horizontally to turn on/off
2. Short press to cycle the different modes, LED will flash when cycled

6.2 Operational Modes

MODE	TYPICAL USAGE
NORMAL	EVERYDAY OPTIMIZED POWER
BOOST	MAX COVERAGE FOR DEMANDING SITUATION
SILENT	LOWER POWER FOR QUIET ENVIRONMENT

6.3 Mode Selection

Immediately after turning on, default mode is set to Normal.

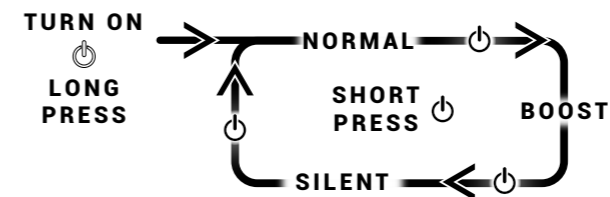

6.4 Charging

1. Charge with a Micro-USB cable
2. Connect the Micro-USB plug to the Air Halo
3. Connect the USB plug to a power adapter

CONDITION	LED
BATTERY LOW	FLASH FOR ~60SECS~
CHARGING	FLASH 6 TIMES*
BATTERY FULL	ON

*LOW-LIGHT MODE: LED WILL TURN OFF WITHIN A SET TIME

7 AIR HALOS IN A PAIR

Pairing allows two Air Halos to function as one when placed together or occupy the same cupholder. Control both from any button and charge from one USB cable.

Before Pairing, **Switch ON** both Air Halos

7.1 Air Halo Pairing

1. Place the rear flat face of the Air Halos together
2. Align the Pairing Link at the bottom
3. Both units will snap together magnetically
4. Air Halos will begin pairing automatically
5. Wait a few seconds for pairing to finish and do not separate the connection
6. Once synchronised, paired control will now be enabled until you separate or switch off

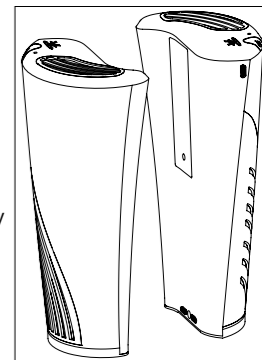

7.2 Mode Selection when Paired

Press on either will control both units. For more details see: **6.1 Function Button**

7.3 Charge When Paired

Only one USB cable connected is required to charge both units when using a generic power adapter at 2.1A or higher. For more details see: **6.4 Charging**

8 MAINTENANCES

8.1 Cleaning recommendation

Before cleaning please **Turn Off**.

1. Surfaces: Slightly damp cloth
2. In-vent: Cotton bud & vacuum
3. Out-vent: Wash dust filter & vacuum

8.2 Surfaces

Use a slightly damp cloth to wipe clean any blemish or dirt on the surface.

8.3 In-vent

Vacuum the in-vent carefully, use a cotton bud to remove dirt and dust from between the vents.

8.4 Out-vent

1. Insert a small and thin tool into the pinhole
2. Push firmly until it clicks and/or the vent cover pops out
3. Remove the dust filter, wash clean and dry

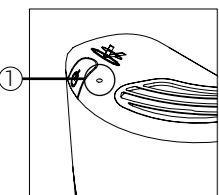

4. Vacuum clean any dust or obstruction within
5. Return the dry dust filter and align vent cover
6. Push vent cover down until it locks securely

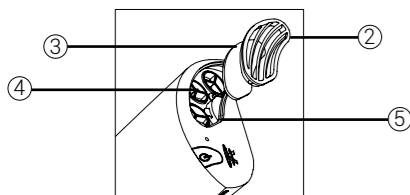

8.5 Battery Replacement

CAUTION: Replacing the Li-ion battery incorrectly will severely damage your Air Halo.

To replace the rechargeable Li-ion battery:

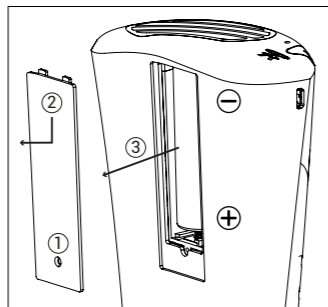

1. Unscrew the fastener
2. Remove the battery cover
3. Replace battery with Positive (+) end facing downwards
4. Re-fasten the battery cover

8.6 Battery Disposal

Damaged Li-ion battery should be recycled or disposed separately from household waste.

8.7 Repair

Maintenance repair by user is not advised. For more details please see: **11.1 Warranty**

9 SPECIFICATIONS

- Model: AH01
- Power Mode: Silent / Normal / Boost
- Weight: 325g
- Air Sanitizer Technology: Plascide reactors
- Recommend Usage: 1m³
- Input: 5V \equiv 2.1A+
- Li-ion Battery: 18650 (cylinder-type)
- Dimension: 183mm (H), 63mm–83mm (W), 34mm–63mm (D)

SUBJECT TO CHANGE WITHOUT PRIOR NOTICE

10 TROUBLESHOOTING

10.1 Diagnostic

SYMPTOM	DIAGNOSIS	ACTION
LED FLASHES FOR 6 TIMES	BATTERY CHARGING	PLEASE SEE: 6.4 Charging
LED STOP FLASHING AFTER 6 TIMES	LOW-LIGHT MODE ON	
LED STEADY ON	BATTERY FULL	UNPLUG POWERED USB CABLE
FAN TURN OFF & LED FLASHES FOR ~60SECS~	BATTERY EMPTY	PLUG POWERED USB CABLE
NO RESPONSE FROM BUTTON		
FAN SLOW DOWN WHEN POWERED USB CABLE PLUGGED	USB POWER ADAPTER OR/AND POWERED USB CABLE INADEQUATE	REQUIRE USB POWER ADAPTER OR/AND POWERED USB CABLE RATED FOR 2.1A OR HIGHER
FAN SLOW DOWN WHEN PAIRED AND POWERED USB CABLE PLUGGED		
NO RESPONSE AFTER REPEATED 6HR FULL CHARGING	BATTERY DEAD	PLEASE SEE: 8.5 Battery Replacement
VERY SHORT OPERATION AFTER REPEATED 6HR FULL CHARGING		
FAN/LED RESPONSE ONLY WITH POWERED USB CABLE PLUGGED		
NO LED/FAN RESPONSE WITH POWERED USB CABLE PLUGGED AND NO BATTERY INSTALLED	PRODUCT FAULT	PLEASE SEE: 11.1 Warranty

11 SERVICE & SUPPORT

11.1 Warranty

- Air Halo is covered by a manufacturer guarantee and warranty
- Self-repair and/or signs of tampering will void the warranty
- Repairs should only be carried out by a certified person
- Please refer to the included warranty card for more details

11.2 Support

For all the latest Air Halo's documentation, please visit the support webpage:

www.a-onetech.com.hk/en-downloads

11.3 Contact

If your warranty card or any accessories are missing, please contact your nearest service centre or alternatively contact the main office:

TEL: (+852) 21531812
 FAX: (+852) 21531813
 EMAIL: cs@a-onetech.com.hk
 WEB: www.a-onetech.com.hk

This device complies with Part 15 of the FCC Rules.

Operation is subject to the following two conditions: (1) This device may not cause harmful interference, and (2) This device must accept any interference received, including interference that may cause undesired operations. CAN ICE-3 (B)/NMB-3(B)



Plascide®
Plasma technology



A-ONETECH.LTD@2018 | V3.0

AIR HALO PORTABLE AIR SANITIZER

EN

INSTRUCTION MANUAL

Model: AH01

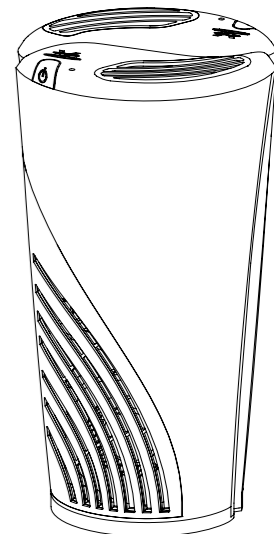
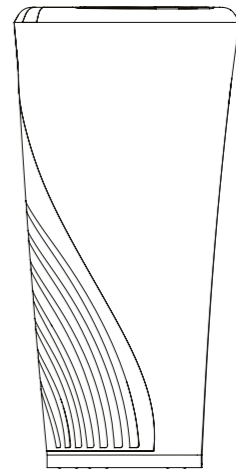

1. OVERVIEW
2. KEY FEATURES
3. PACKAGE CONTENT
4. QUICK START GUIDE
5. SAFETY PRECAUTIONS
6. OPERATION GUIDE
7. AIR HALOS IN A PAIR
8. MAINTENANCES
9. SPECIFICATIONS
10. TROUBLESHOOTING
11. SERVICE & SUPPORT



PLEASE READ THIS MANUAL BEFORE USE